

## Classica



**Corpo:**

Classica: in policarbonato bianco autoestinguente  
Classica metal: in alluminio satinato

**Schermo:** diffusore rigato in PMMA

**Portalamпада:** materiale termoplastico

**Lampada:** Leuci

**Cablaggio:** completo di alimentazione elettronica, dotato di interruttore, cavo di 2m e spina, ballast munito di protezione fine vita tubo fluorescente (EOL).

**Body:**

Classica: in self-extinguishing polycarbonate  
Classica metal: in satin aluminium

**Shield:** PMMA diffuser

**Lamp holder:** thermoplastic material

**Lamp:** Lamp

**Wiring:** complete with electronic power supply equipped with switch, 2m wire and plug, ballast provided with fluorescent tube end-of-life protection (EOL).



**ACCESSORI INCLUSI  
ACCESSORIES SUPPLIED**

Reglette e Strisce led rigide - Fluorescent fittings and rigid Strips

TECNICO - TECHNICAL

**Classica ACCESSORI  
Classica ACCESSORIES**



Lampade di ricambio 4100°K  
*Spare lamp 4100°K*

- 8W Cod. 28500/LAMP (Leuci 400361.0101)
- 13W Cod. 28501/LAMP (Leuci 400365.0101)
- 21W Cod. 28502/LAMP (Leuci 400145.0101)
- 28W Cod. 28503/LAMP (Leuci 400150.0101)
- 35W Cod. Leuci 400155.0101

Lampade di ricambio 3000°K  
*Spare lamp 3000°K*

- 8W Cod. 30930/LAMP
- 13W Cod. 30931/LAMP
- 21W Cod. 30932/LAMP (Leuci 400144.0101)
- 28W Cod. 30933/LAMP (Leuci 400149.0101)
- 35W Cod. Leuci 400154.0101

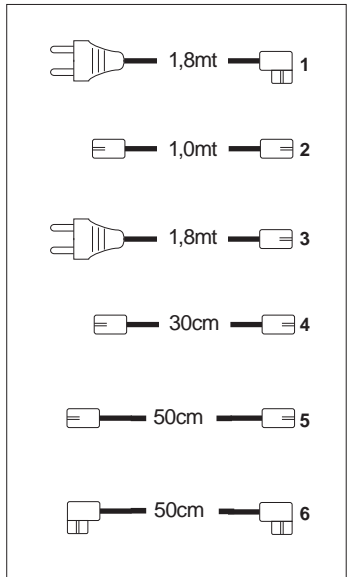

- (1)** Cod. 24151  
cavo di 1,8 mt con connettore a 90°  
*1.8 mt wire with connector at 90°*
- (2)** Cod. 24121  
cavo di 1 mt con due connettori  
*1 mt wire with 2 connectors*
- (3)** Cod. 24153  
cavo di 1,8 mt con connettore  
*1.8 mt wire with connector*
- (4)** Cod. 24156  
cavo di 30 cm con due connettori  
*30 cm wire with two connector*
- (5)** Cod. 24159  
cavo di 50 cm con due connettori a 90°  
*50 cm wire with two connector*
- (6)** Cod. 24160  
cavo di 50 cm con due connettori  
*50 cm wire with two 90° connector*

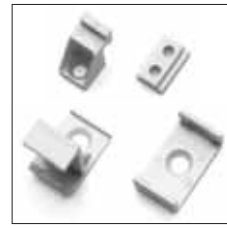

Cod. 24154  
accessori fissaggio  
*fitting accessories*

## Classica

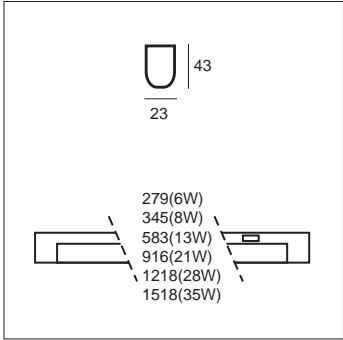
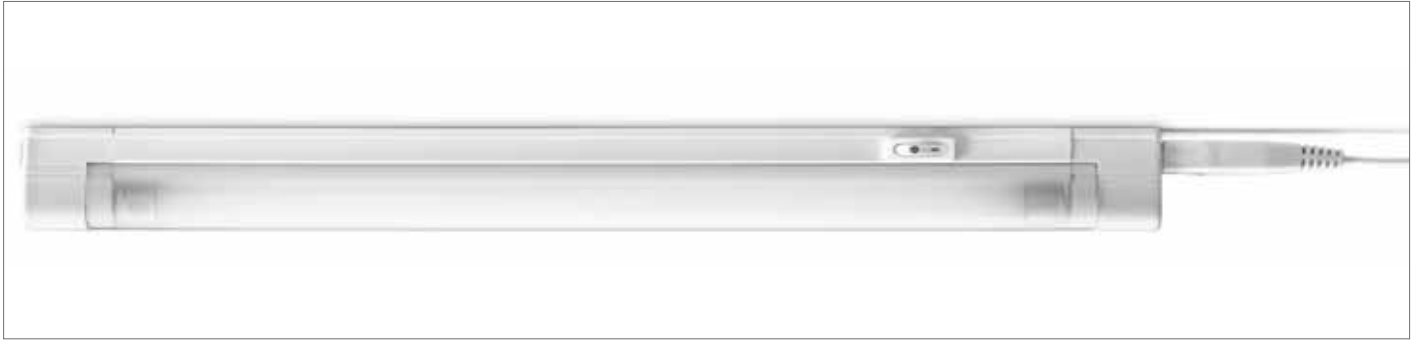

230V 50Hz 03

**IP20**  
**IK07**

colour	W		K	pcs	dm <sup>3</sup>	Kg	CELL	
B/W	21	G5 T5	6000	020	2.20	0.50	28487	C
B/W	28	G5 T5	6000	020	2.90	0.80	28488	C
B/W	35	G5 T5	6000	020	3.62	1.00	28489	C
B/W	6	G5 T5	4100	030	0.70	0.30	700930.0101	C
B/W	8	G5 T5	4100	030	0.90	0.340	28500	C
B/W	13	G5 T5	4100	030	1.40	0.40	28501	C
B/W	21	G5 T5	4100	020	2.20	0.50	28502	C
B/W	28	G5 T5	4100	020	2.90	0.80	28503	C
B/W	35	G5 T5	4100	012	3.62	1.00	* 30964	C
B/W	6	G5 T5	3000	030	0.70	0.30	700932.0101	C
B/W	8	G5 T5	3000	030	0.90	0.30	30930	C
B/W	13	G5 T5	3000	030	1.40	0.40	30931	C
B/W	21	G5 T5	3000	020	2.20	0.50	30932	C
B/W	28	G5 T5	3000	020	2.90	0.80	30933	C
B/W	35	G5 T5	3000	012	3.62	1.00	* 30965	C

\* In fase approvazione - Under approval

### Classica senza interruttore

### Classica without switch



colour	W		K	pcs	dm <sup>3</sup>	Kg	CELL	
B/W	6	G5 T5	4100	020	0.70	0.30	701050.0103	C
B/W	8	G5 T5	4100	020	0.86	0.30	701051.0103	C
B/W	13	G5 T5	4100	020	0.86	0.30	701052.0103	C

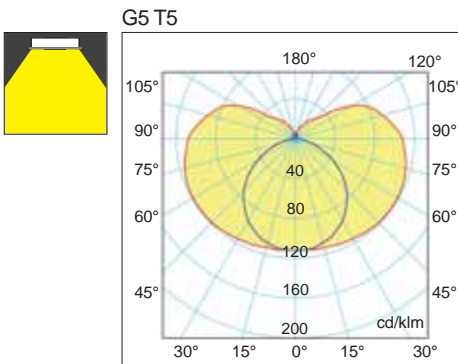



È possibile cablare le lampade in serie fino ad una potenza totale di 200W.

Si suggerisce comunque di utilizzare lampade della stessa potenza. Diversamente potrebbero notarsi piccole differenze di colore tra lampade di diversa potenza.

*The lamps can be connected in series up to a total power of 200W.*

*You are however advised to use lamps of the same power. Lamps of different power can cause variations in colour.*



## Classica metal

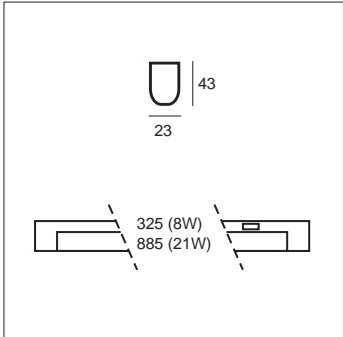
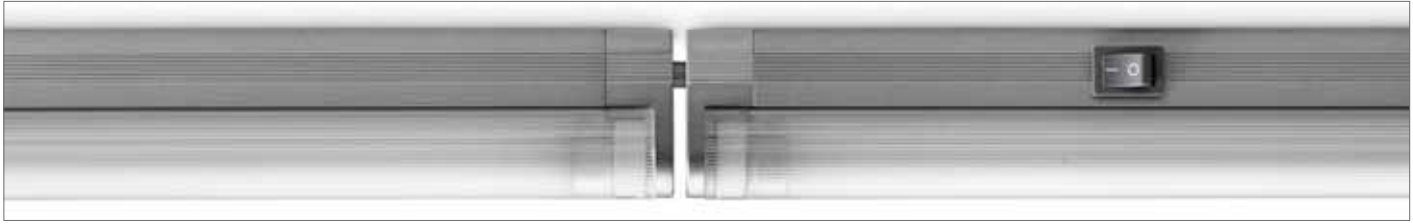

230V 50Hz

**IP40**  
**IK08**

colour	W		K	pcs	dm <sup>3</sup>	Kg	CELL
<u>S</u> / <u>L</u>	8	G5 T5	4100	030	0.90	0.28	30960
<u>S</u> / <u>L</u>	21	G5 T5	4100	030	2.20	0.58	30962

## Classica 120V

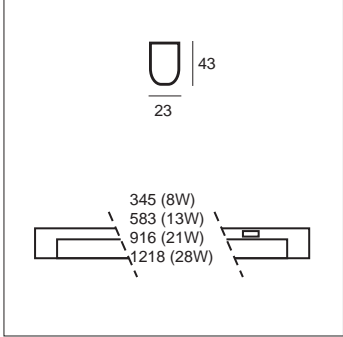

120V 50/60Hz

**IP20**  
**IK08**

colour	W		K	pcs	dm <sup>3</sup>	Kg	CELL
<u>B</u> / <u>W</u>	8	G5 T5	4100	030	0.90	0.28	28580
<u>B</u> / <u>W</u>	13	G5 T5	4100	030	1.40	0.40	28581
<u>B</u> / <u>W</u>	21	G5 T5	4100	030	2.20	0.58	28582
<u>B</u> / <u>W</u>	28	G5 T5	4100	030	2.90	0.82	28583

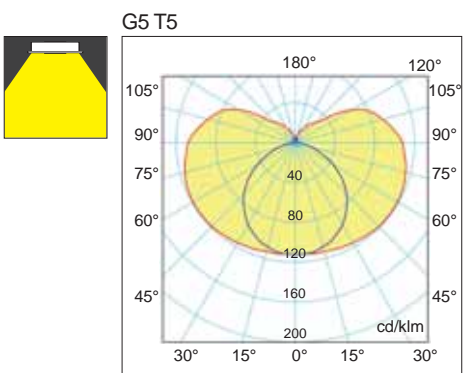

Espositore Reglette - Fluorescent fitting display board  
cod. 000012



Reglette e Strisce led rigide - Fluorescent fittings and rigid Strips

TECNICO - TECHNICAL

## Traccia (accessorio per Classica - accessory for Classica) Design by Ezio Didone



**Corpo:** accessorio per plafoniera Classica realizzato in alluminio estruso di diverse lunghezze al fine di poter essere utilizzato con tutte le potenze.

**Verniciatura:** polvere termoindurente poliestere.

**Cablaggio:** Possibilità di collegamento in serie mediante cavetti termoplastici di 15cm finalizzati alla rotazione assiale degli apparecchi.

L'alimentazione tramite cavo 1.8m con presa europea e spinotto a 90° permette il risparmio di spazio e la scomparsa del cavo stesso nell'applicazione a plafone. L'installazione può essere a sospensione mediante cavi, a plafone o a parete.

**Body:** An accessory for Classica lamp realised in extruded aluminium in different lengths relative to the type of voltage used 8/13/21/28W.







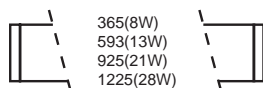
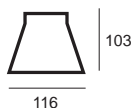





**Coating:** painted with thermo hardening polyester.

**Wiring:** Possibility of connecting in series by means of thermoplastic wires of 15 cm finalised by the axle rotation of the fittings.

The power supply by means of a 1.8m wire with European socket and pin at 90° save space and the wire is hidden inside the ceiling appliance. The installation can be suspended by using the wire, on ceiling or wall.



IP20 CE

colour	W	pcs	dm <sup>3</sup>	Kg	S
 	per/for CLASSICA 8W	020	4.75	0.60	28570 
 	per/for CLASSICA 13W	020	7.75	0.98	28571 
 	per/for CLASSICA 21W	010	12.1	1.55	28572 
 	per/for CLASSICA 28W	010	2.08	2.08	28573 

### ACCESSORI ACCESSORIES



Cod. 702197.0101  
rosone  
rose



Cod. 702196.0101  
braccio a parete  
wall bracket

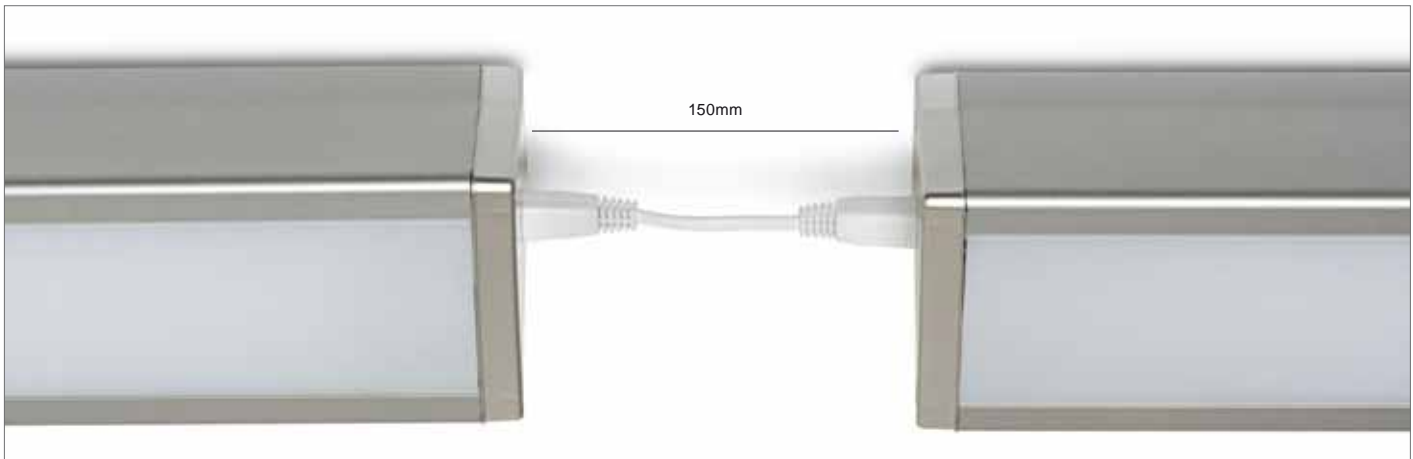
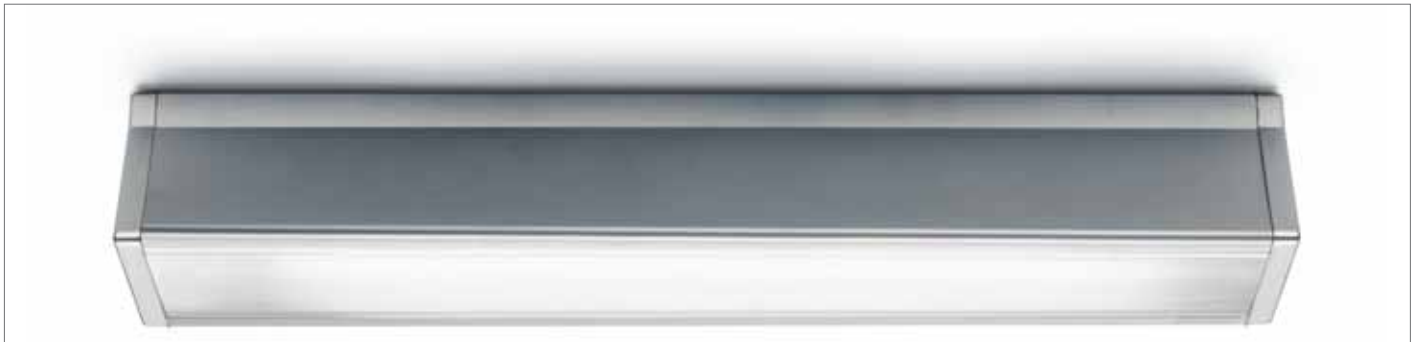

È possibile cablare le lampade in serie fino ad una potenza totale di 200W.

Si suggerisce comunque di utilizzare lampade della stessa potenza. Diversamente potrebbero notarsi piccole differenze di colore tra lampade di diversa potenza.

*The lamps can be connected in series up to a total power of 200W.*

*You are however advised to use lamps of the same power. Lamps of different power can cause variations in colour.*

## Classica 54W



**Corpo:** in alluminio verniciato

**Schermo:** diffusore rigato in PMMA

**Portalampada:** materiale termoplastico G5

**Lampada:** LEUCI T5

**Cablaggio:** completo di alimentatore elettronico Relco, dotato di interruttore On-Off. Cavo con spina di lunghezza 1,7 m e connessione rapida alla lampada.

La connessione in serie è possibile solo mediante l'utilizzo dell'apposito cavetto.

**Body:** painted aluminium

**Screen:** PMMA diffuser

**Lamp holder:** thermoplastic material G5

**Lamp:** LEUCI T5

**Wiring:** complete with Relco electronic ballast, On-Off switch, 1.7 m cable with plug and quick connection to lamp.

Connection in series is only possible with the respective cable

### ACCESSORI ACCESSORIES

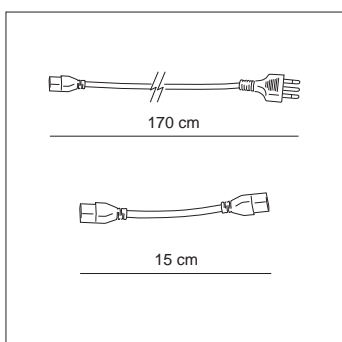

Si possono collegare fino ad un massimo di 5 reglette in serie  
A maximum number of five lamp mount devices can be mounted in series

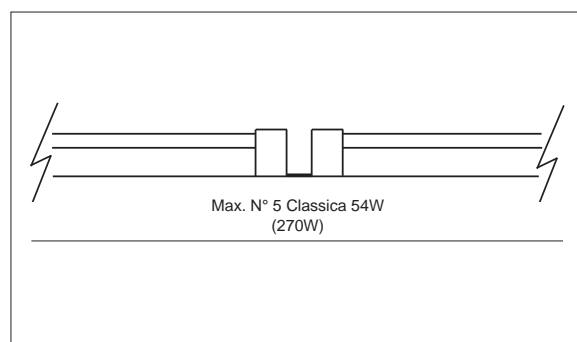

## Classica 54W

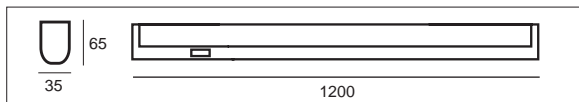

**IP20**  
**IK07**



colour	W		K	pcs	dm <sup>3</sup>	Kg	CELL
B/W	54	G5 T5	4000	020	3.00	1.20	28575 <span style="background-color: #00aaff; color: white; padding: 2px;">C</span>
B/W	54	G5 T5	3000	020	3.00	1.20	28574 <span style="background-color: #00aaff; color: white; padding: 2px;">C</span>



**ACCESSORI INCLUSI**  
**ACCESSORIES SUPPLIED**

